

# FDS6676AS

## 30V N-Channel PowerTrench® SyncFET™

### General Description

The FDS6676AS is designed to replace a single SO-8 MOSFET and Schottky diode in synchronous DC:DC power supplies. This 30V MOSFET is designed to maximize power conversion efficiency, providing a low  $R_{DS(ON)}$  and low gate charge. The FDS6676AS includes an integrated Schottky diode using Fairchild's monolithic SyncFET technology.

### Applications

- DC/DC converter
- Low side notebook



### Features

- 14.5 A, 30 V.  $R_{DS(ON)}$  max= 6.0 m $\Omega$  @  $V_{GS} = 10$  V  
 $R_{DS(ON)}$  max= 7.25 m $\Omega$  @  $V_{GS} = 4.5$  V
- Includes SyncFET Schottky body diode
- Low gate charge (45nC typical)
- High performance trench technology for extremely low  $R_{DS(ON)}$  and fast switching
- High power and current handling capability
- RoHS Compliant

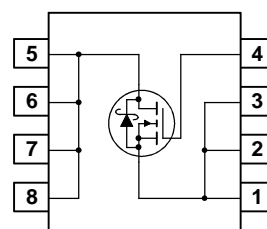
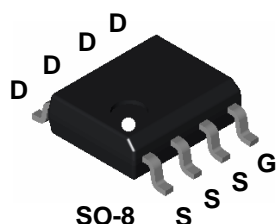

### Absolute Maximum Ratings T<sub>A</sub>=25°C unless otherwise noted

Symbol	Parameter	Ratings	Units
$V_{DSS}$	Drain-Source Voltage	30	V
$V_{GSS}$	Gate-Source Voltage	$\pm 20$	V
$I_D$	Drain Current – Continuous (Note 1a)	14.5	A
	– Pulsed	50	
$P_D$	Power Dissipation for Single Operation (Note 1a) (Note 1b) (Note 1c)	2.5	W
		1.2	
		1	
$T_J, T_{STG}$	Operating and Storage Junction Temperature Range	-55 to +150	°C

### Thermal Characteristics

$R_{\theta JA}$	Thermal Resistance, Junction-to-Ambient (Note 1a)	50	°C/W
$R_{\theta JC}$	Thermal Resistance, Junction-to-Case (Note 1)	25	

### Package Marking and Ordering Information

Device Marking	Device	Reel Size	Tape width	Quantity
FDS6676AS	FDS6676AS	13"	12mm	2500 units

## Electrical Characteristics

$T_A = 25^\circ\text{C}$  unless otherwise noted

Symbol	Parameter	Test Conditions	Min	Typ	Max	Units
--------	-----------	-----------------	-----	-----	-----	-------

### Off Characteristics

$BV_{DSS}$	Drain–Source Breakdown Voltage	$V_{GS} = 0\text{ V}, I_D = 1\text{ mA}$	30			V
$\frac{\Delta BV_{DSS}}{\Delta T_J}$	Breakdown Voltage Temperature Coefficient	$I_D = 10\text{ mA}$ , Referenced to $25^\circ\text{C}$		20		mV/°C
$I_{DSS}$	Zero Gate Voltage Drain Current	$V_{DS} = 24\text{ V}, V_{GS} = 0\text{ V}$			500	$\mu\text{A}$
$I_{GSS}$	Gate–Body Leakage	$V_{GS} = \pm 20\text{ V}, V_{DS} = 0\text{ V}$			$\pm 100$	nA

### On Characteristics (Note 2)

$V_{GS(th)}$	Gate Threshold Voltage	$V_{DS} = V_{GS}, I_D = 1\text{ mA}$	1	1.5	3	V
$\frac{\Delta V_{GS(th)}}{\Delta T_J}$	Gate Threshold Voltage Temperature Coefficient	$I_D = 10\text{ mA}$ , Referenced to $25^\circ\text{C}$		–4		mV/°C
$R_{DS(on)}$	Static Drain–Source On–Resistance	$V_{GS} = 10\text{ V}, I_D = 14.5\text{ A}$ $V_{GS} = 4.5\text{ V}, I_D = 13.2\text{ A}$ $V_{GS} = 10\text{ V}, I_D = 14.5\text{ A}, T_J = 125^\circ\text{C}$		4.5 5.9 6.7	6.0 7.25 8.5	m $\Omega$
$I_{D(on)}$	On–State Drain Current	$V_{GS} = 10\text{ V}, V_{DS} = 5\text{ V}$	50			A
$g_{FS}$	Forward Transconductance	$V_{DS} = 10\text{ V}, I_D = 14.5\text{ A}$		66		S

### Dynamic Characteristics

$C_{iss}$	Input Capacitance	$V_{DS} = 15\text{ V}, V_{GS} = 0\text{ V},$ $f = 1.0\text{ MHz}$		2510		pF
$C_{oss}$	Output Capacitance			710		pF
$C_{riss}$	Reverse Transfer Capacitance			270		pF
$R_G$	Gate Resistance	$V_{GS} = 15\text{ mV}, f = 1.0\text{ MHz}$		1.6	2.8	$\Omega$

### Switching Characteristics (Note 2)

$t_{d(on)}$	Turn–On Delay Time	$V_{DD} = 15\text{ V}, I_D = 1\text{ A},$ $V_{GS} = 10\text{ V}, R_{GEN} = 6\ \Omega$		10	20	ns
$t_r$	Turn–On Rise Time			12	22	ns
$t_{d(off)}$	Turn–Off Delay Time			43	69	ns
$t_f$	Turn–Off Fall Time			29	46	ns
$t_{d(on)}$	Turn–On Delay Time	$V_{DD} = 15\text{ V}, I_D = 1\text{ A},$ $V_{GS} = 4.5\text{ V}, R_{GEN} = 6\ \Omega$		17	31	ns
$t_r$	Turn–On Rise Time			22	35	ns
$t_{d(off)}$	Turn–Off Delay Time			34	54	ns
$t_f$	Turn–Off Fall Time			29	46	ns
$Q_{g(TOT)}$	Total Gate Charge at $V_{GS}=10\text{V}$	$V_{DD} = 15\text{ V}, I_D = 14.5\text{ A},$		45	63	nC
$Q_g$	Total Gate Charge at $V_{GS}=5\text{V}$			25	35	nC
$Q_{gs}$	Gate–Source Charge			7		nC
$Q_{gd}$	Gate–Drain Charge			8		nC

### Electrical Characteristics

$T_A = 25^\circ\text{C}$  unless otherwise noted

Symbol	Parameter	Test Conditions	Min	Typ	Max	Units
<b>Drain–Source Diode Characteristics and Maximum Ratings</b>						
$V_{SD}$	Drain–Source Diode Forward Voltage	$V_{GS} = 0\text{ V}, I_S = 3.5\text{ A}$ (Note 2) $V_{GS} = 0\text{ V}, I_S = 7\text{ A}$ (Note 2)		0.4 0.5	0.7	V
$t_{rr}$	Diode Reverse Recovery Time	$I_F = 14.5\text{ A},$ $dI_F/dt = 300\text{ A}/\mu\text{s}$ (Note 3)		27		nS
$I_{RM}$	Diode Reverse Recovery Current			1.9		A
$Q_{rr}$	Diode Reverse Recovery Charge			26		nC

**Notes:**

1.  $R_{\theta JA}$  is the sum of the junction-to-case and case-to-ambient thermal resistance where the case thermal reference is defined as the solder mounting surface of the drain pins.  $R_{\theta JC}$  is guaranteed by design while  $R_{\theta CA}$  is determined by the user's board design.

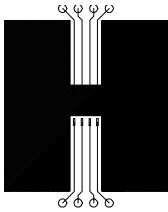

a) 50°W when mounted on a 1 in<sup>2</sup> pad of 2 oz copper

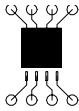

b) 105°W when mounted on a .04 in<sup>2</sup> pad of 2 oz copper

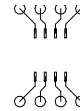

## Typical Characteristics

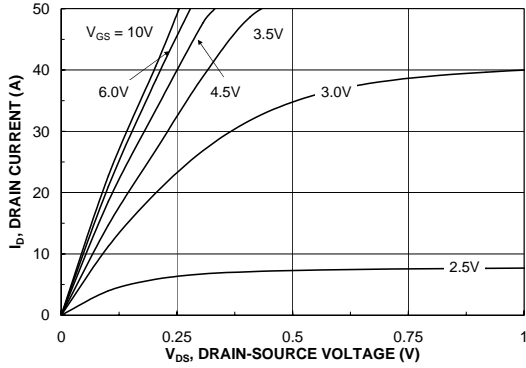

Figure 1. On-Region Characteristics.

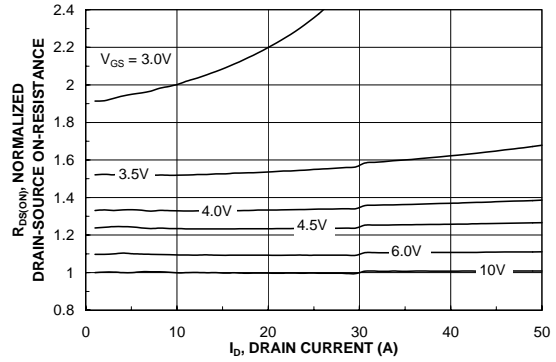

Figure 2. On-Resistance Variation with Drain Current and Gate Voltage.

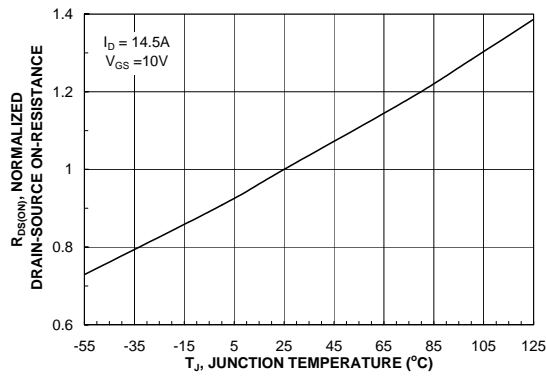

Figure 3. On-Resistance Variation with Temperature.

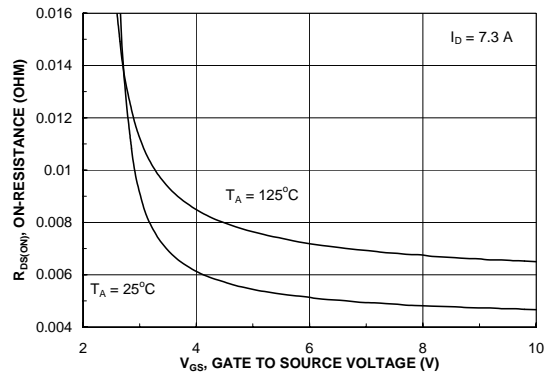

Figure 4. On-Resistance Variation with Gate-to-Source Voltage.

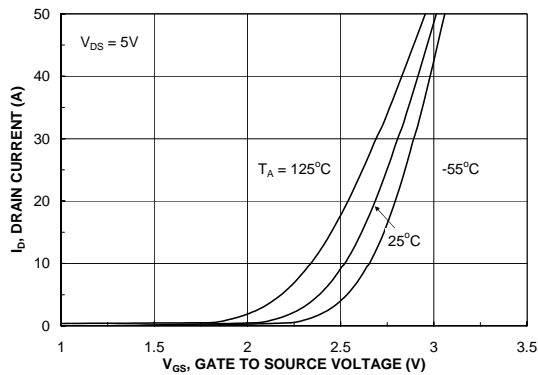

Figure 5. Transfer Characteristics.

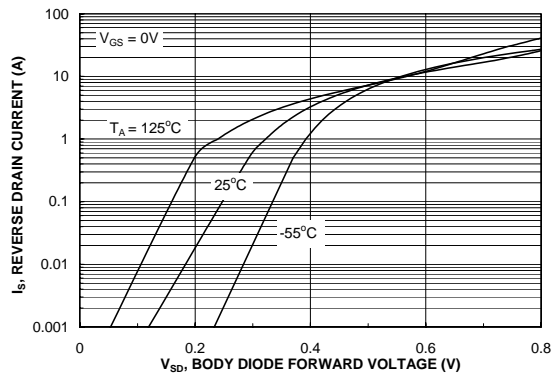
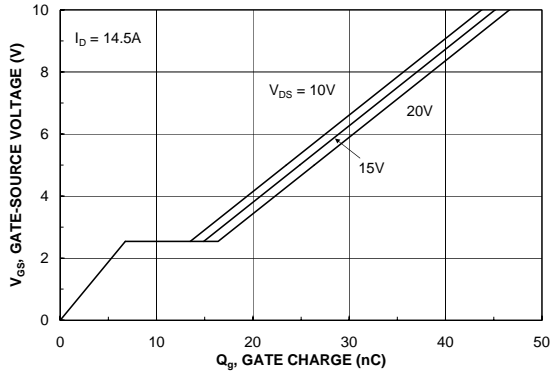
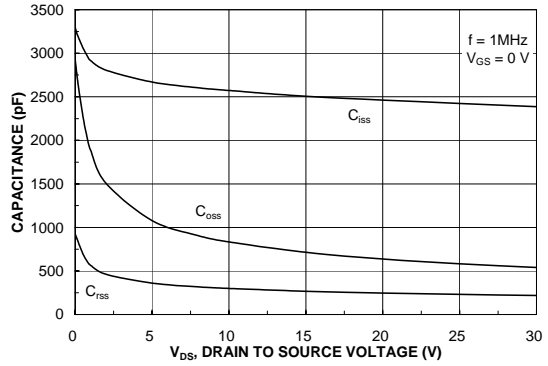

Figure 6. Body Diode Forward Voltage Variation with Source Current and Temperature.

**Typical Characteristics** (continued)



**Figure 7. Gate Charge Characteristics.**



**Figure 8. Capacitance Characteristics.**

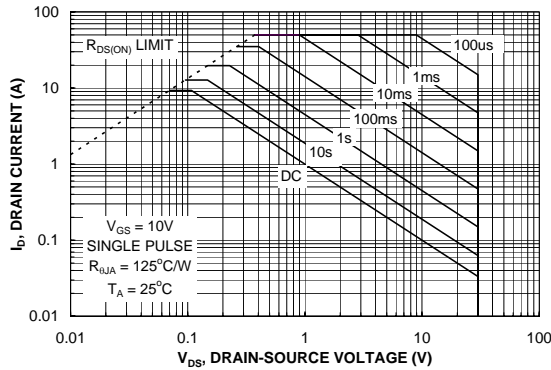

**Figure 9. Maximum Safe Operating Area.**

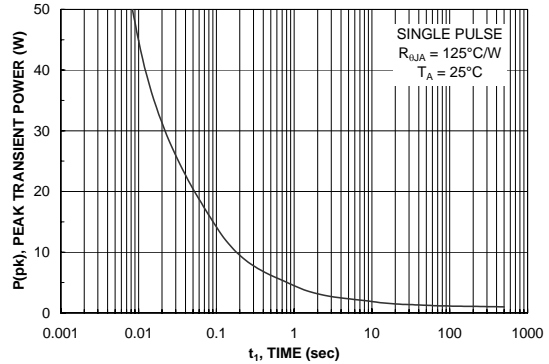

**Figure 10. Single Pulse Maximum Power Dissipation.**

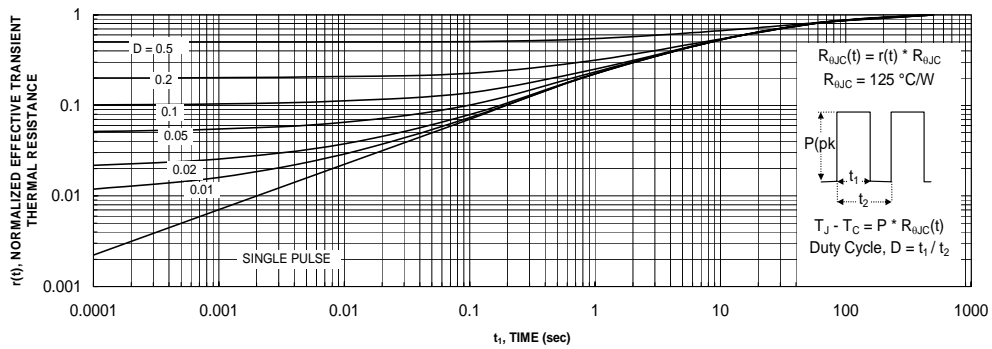

**Figure 11. Transient Thermal Response Curve.**

Thermal characterization performed using the conditions described in Note 1c.  
Transient thermal response will change depending on the circuit board design.

**Typical Characteristics** (continued)

**SyncFET Schottky Body Diode Characteristics**

Fairchild's SyncFET process embeds a Schottky diode in parallel with PowerTrench MOSFET. This diode exhibits similar characteristics to a discrete external Schottky diode in parallel with a MOSFET. Figure 12 shows the reverse recovery characteristic of the FDS6676AS.

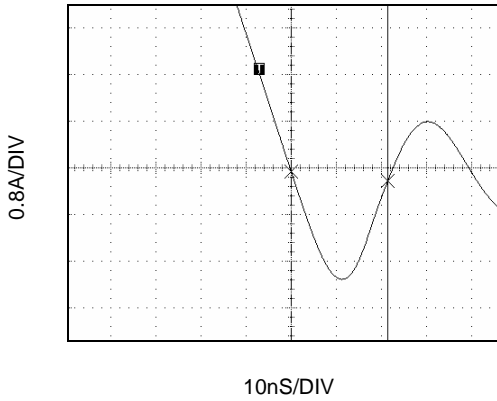

**Figure 12. FDS6676AS SyncFET body diode reverse recovery characteristic.**

For comparison purposes, Figure 13 shows the reverse recovery characteristics of the body diode of an equivalent size MOSFET produced without SyncFET (FDS6676).

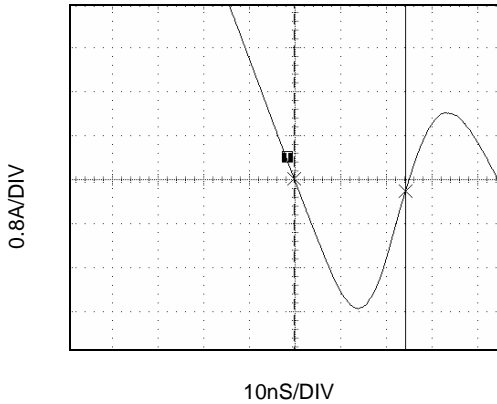

**Figure 13. Non-SyncFET (FDS6676) body diode reverse recovery characteristic.**

Schottky barrier diodes exhibit significant leakage at high temperature and high reverse voltage. This will increase the power in the device.

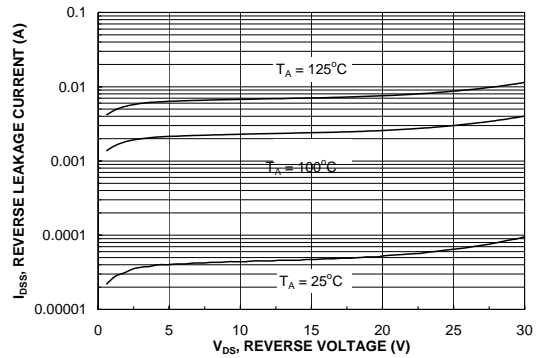

**Figure 14. SyncFET body diode reverse leakage versus drain-source voltage and temperature.**

### Typical Characteristics

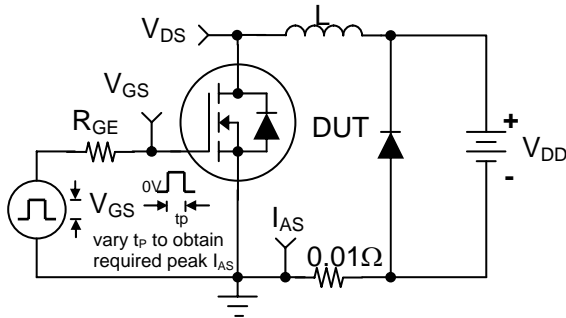

Figure 15. Unclamped Inductive Load Test Circuit

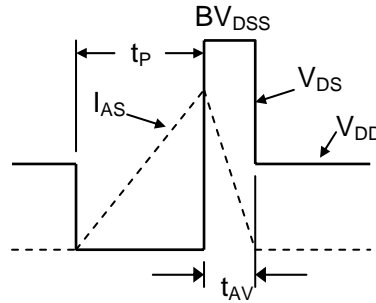

Figure 16. Unclamped Inductive Waveforms

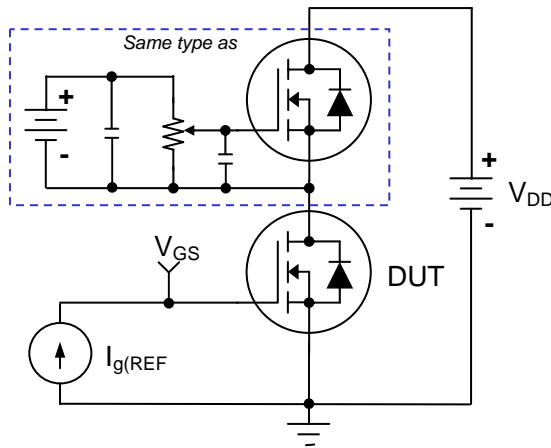

Figure 17. Gate Charge Test Circuit

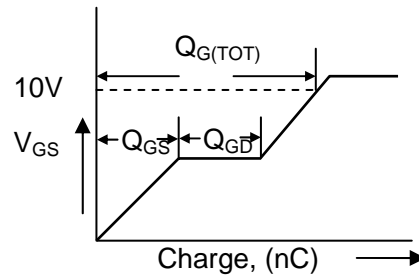

Figure 18. Gate Charge Waveform

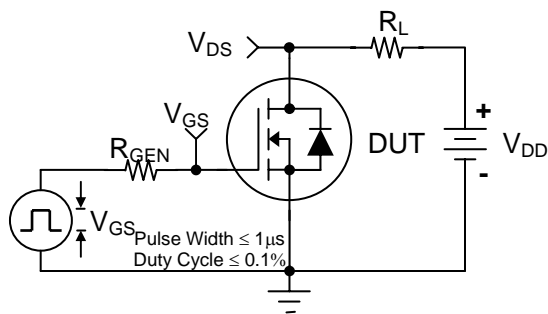

Figure 19. Switching Time Test Circuit

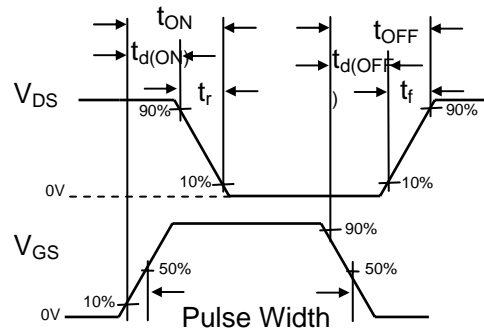







Figure 20. Switching Time Waveforms



**TRADEMARKS**

The following includes registered and unregistered trademarks and service marks, owned by Fairchild Semiconductor and/or its global subsidiaries, and is not intended to be an exhaustive list of all such trademarks.

- |                                                                                   |                                                                                   |                                                                                   |                                                                                     |
|-----------------------------------------------------------------------------------|-----------------------------------------------------------------------------------|-----------------------------------------------------------------------------------|-------------------------------------------------------------------------------------|
| ACEx®                                                                             | FPS™                                                                              | PDP-SPM™                                                                          | The Power Franchise®                                                                |
| Build it Now™                                                                     | F-PFS™                                                                            | Power-SPM™                                                                        | <b>power</b><br>the franchise                                                       |
| CorePLUS™                                                                         | FRFET®                                                                            | PowerTrench®                                                                      | TinyBoost™                                                                          |
| CorePOWER™                                                                        | Global Power ResourceSM                                                           | Programmable Active Droop™                                                        | TinyBuck™                                                                           |
| CROSSVOLT™                                                                        | Green FPS™                                                                        | QFET®                                                                             | TinyLogic®                                                                          |
| CTL™                                                                              | Green FPS™ e-Series™                                                              | QS™                                                                               | TINYOPTO™                                                                           |
| Current Transfer Logic™                                                           | GTO™                                                                              | Quiet Series™                                                                     | TinyPower™                                                                          |
| EcoSPARK®                                                                         | IntelliMAX™                                                                       | RapidConfigure™                                                                   | TinyPWM™                                                                            |
| EfficientMax™                                                                     | ISOPLANAR™                                                                        | Saving our world 1mW at a time™                                                   | TinyWire™                                                                           |
| EZSWITCH™ *                                                                       | MegaBuck™                                                                         | SmartMax™                                                                         | µSerDes™                                                                            |
|  | MICROCOUPLER™                                                                     | SMART START™                                                                      |  |
|  | MicroFET™                                                                         | SPM®                                                                              | UHC®                                                                                |
| Fairchild®                                                                        | MicroPak™                                                                         | STEALTH™                                                                          | Ultra FRFET™                                                                        |
| Fairchild Semiconductor®                                                          | MillerDrive™                                                                      | SuperFET™                                                                         | UniFET™                                                                             |
| FACT Quiet Series™                                                                | MotionMax™                                                                        | SuperSOT™-3                                                                       | VCX™                                                                                |
| FACT®                                                                             | Motion-SPM™                                                                       | SuperSOT™-6                                                                       | VisualMax™                                                                          |
| FAST®                                                                             | OPTOLOGIC®                                                                        | SuperSOT™-8                                                                       |                                                                                     |
| FastvCore™                                                                        | OPTOPLANAR®                                                                       | SuperMOS™                                                                         |                                                                                     |
| FlashWriter® *                                                                    |  |  |                                                                                     |

\* EZSWITCH™ and FlashWriter® are trademarks of System General Corporation, used under license by Fairchild Semiconductor.

**DISCLAIMER**

FAIRCHILD SEMICONDUCTOR RESERVES THE RIGHT TO MAKE CHANGES WITHOUT FURTHER NOTICE TO ANY PRODUCTS HEREIN TO IMPROVE RELIABILITY, FUNCTION, OR DESIGN. FAIRCHILD DOES NOT ASSUME ANY LIABILITY ARISING OUT OF THE APPLICATION OR USE OF ANY PRODUCT OR CIRCUIT DESCRIBED HEREIN; NEITHER DOES IT CONVEY ANY LICENSE UNDER ITS PATENT RIGHTS, NOR THE RIGHTS OF OTHERS. THESE SPECIFICATIONS DO NOT EXPAND THE TERMS OF FAIRCHILD'S WORLDWIDE TERMS AND CONDITIONS, SPECIFICALLY THE WARRANTY THEREIN, WHICH COVERS THESE PRODUCTS.

**LIFE SUPPORT POLICY**

FAIRCHILD'S PRODUCTS ARE NOT AUTHORIZED FOR USE AS CRITICAL COMPONENTS IN LIFE SUPPORT DEVICES OR SYSTEMS WITHOUT THE EXPRESS WRITTEN APPROVAL OF FAIRCHILD SEMICONDUCTOR CORPORATION.

As used herein:

- Life support devices or systems are devices or systems which, (a) are intended for surgical implant into the body or (b) support or sustain life, and (c) whose failure to perform when properly used in accordance with instructions for use provided in the labeling, can be reasonably expected to result in a significant injury of the user.
- A critical component in any component of a life support, device, or system whose failure to perform can be reasonably expected to cause the failure of the life support device or system, or to affect its safety or effectiveness.

**PRODUCT STATUS DEFINITIONS**

**Definition of Terms**

Datasheet Identification	Product Status	Definition
Advance Information	Formative or In Design	This datasheet contains the design specifications for product development. Specifications may change in any manner without notice.
Preliminary	First Production	This datasheet contains preliminary data; supplementary data will be published at a later date. Fairchild Semiconductor reserves the right to make changes at any time without notice to improve design.
No Identification Needed	Full Production	This datasheet contains final specifications. Fairchild Semiconductor reserves the right to make changes at any time without notice to improve the design.
Obsolete	Not In Production	This datasheet contains specifications on a product that is discontinued by Fairchild Semiconductor. The datasheet is for reference information only.